



High Transfer Efficiency, General Purpose Type Photocoupler LTV4N32/LTV4N33

LITE-ON INC

31E D ■ 5536367 0001667 5 ■ LTN

T-41-85

FEATURES

1. High current transfer ratio
LTV4N32, LTV4N33
(CTR:MIN. 500% at $I_F = 10\text{mA}$, $V_{CE} = 10\text{V}$)
2. Response time t_{ON} :MAX. $5\mu\text{s}$ at $I_F = 200\text{mA}$
 $V_{CC} = 10\text{V}$, $I_C = 50\text{mA}$
3. UL approved (No E113898 (S))

APPLICATIONS

1. I/O interfaces for computers
2. System appliances, measuring instruments
3. Signal transmission between circuits of different potentials and impedances

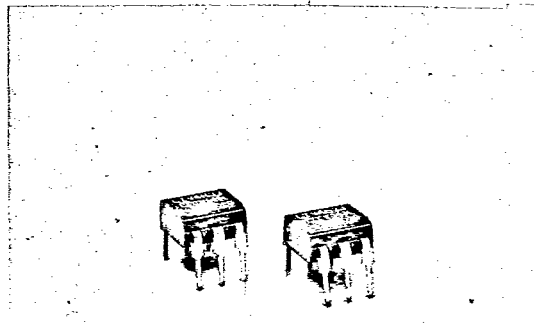

OUTLINE DIMENSIONS (UNIT: mm)

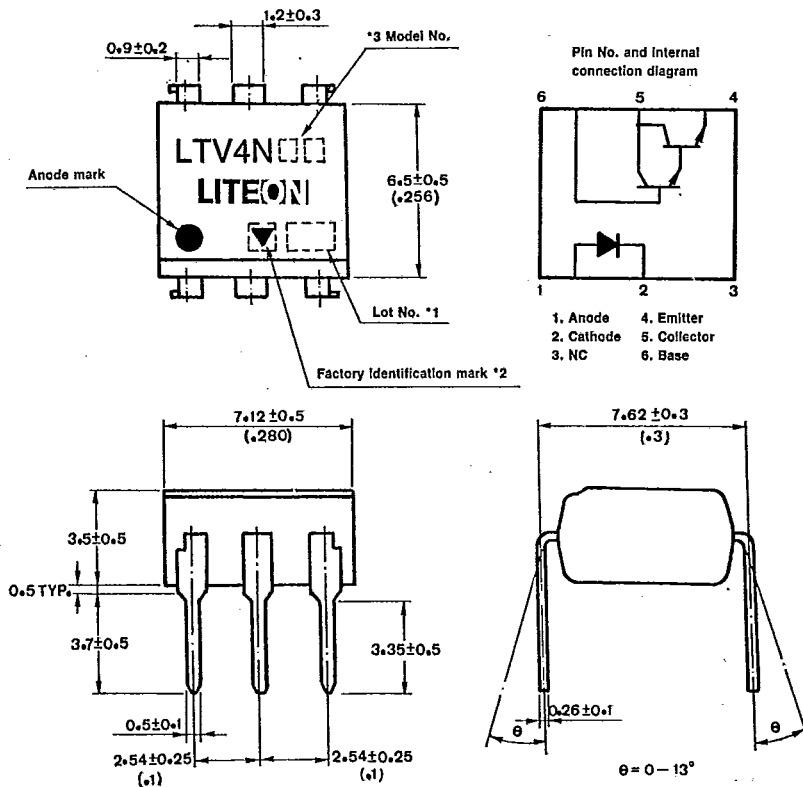

*3 Model No.
LTV4N32
LTV4N33

*1 2-digit number marked according to DIN standard
*2 Factory identification mark shall be or shall not be marked.

■ RATINGS AND CHARACTERISTICS

• Absolute maximum ratings

(Ta=25°C)

Parameter		Symbol	Rating	Unit
Input	Forward current	I_F	80	mA
	*1 Peak forward current	I_{FM}	3	A
	Reverse voltage	V_R	6	V
	Power dissipation	P	150	mW
Output	Collector-emitter voltage	V_{CEO}	30	V
	Collector-base voltage	V_{CBO}	30	V
	Emitter-collector voltage	V_{ECO}	5	V
	Collector current	I_C	100	mA
	Collector power dissipation	P_C	150	mW
Total power dissipation		P_{tot}	250	mW
* 2 Isolation voltage	LTV4N32	V_{iso}	2500	V_{rms}
	LTV4N33		1500	
Operating temperature		T_{opr}	-55 ~ +100	°C
Storage temperature		T_{stg}	-55 ~ +150	°C
* 3 Soldering temperature		T_{sol}	260	°C

*1 Pulse width $\leq 1 \mu s$ Duty ratio:0.001

*2 AC for 1 minute 40~60% R.H;

*3 For 10 seconds

T-41-85

(Ta=25°C)

• Electro-optical characteristics

Parameter		Symbol	Min.	Typ.	Max.	Unit	Conditions
Input	Forward voltage	V_F	—	1.2	1.5	V	$I_F = 10\text{mA}$
	Reverse current	I_R	—	—	10	μA	$V_R = 4\text{V}$
	Terminal capacitance	C_t	—	50	—	pF	$V = 0, f = 1\text{ kHz}$
Output	Collector dark current	I_{CEO}	—	—	100	nA	$V_{CE} = 10\text{V}, I_F = 0$
	Collector-emitter breakdown voltage	BV_{CEO}	30	—	—	V	$I_C = 0.1\text{mA}$ $I_F = 0$
	Emitter-collector breakdown voltage	BV_{ECO}	5	—	—	V	$I_E = 10\mu\text{A}$ $I_F = 0$
	Collector-base breakdown voltage	BV_{CBO}	30	—	—	V	$I_C = 0.1\text{mA}$ $I_F = 0$
Transfer characteristics	*1 Collector current	I_C	50	—	—	mA	$I_F = 10\text{mA}$ $V_{CE} = 10\text{V}$
	Collector-emitter saturation voltage	$V_{CE(sat)}$	—	—	1.0	V	$I_F = 8\text{mA}$ $I_C = 2\text{mA}$
	Isolation resistance	R_{iso}	5×10^{10}	1×10^{11}	—	Ω	DC500V 40~60% R.H.
	Floating capacitance	C_f	—	1.0	—	pF	$V = 0, f = 1\text{MHz}$
	Response time (Turn-on time)	t_{on}	—	—	5	μs	$I_F = 200\text{mA}$ ($t_w \approx 1.0\text{ms}$) $V_{CC} = 10\text{V}$ $I_C = 50\text{mA}$
Response time (Turn-off time)	t_{off}	—	—	100	μs		

*1 Pulse test: Input pulse width = 300 μs Duty ratio ≤ 0.02 , $CTR = \frac{I_C}{I_F} \times 100\%$

**■ SUPPLEMENT****• Isolation voltage shall be measured in the following method.**

- (1) Short between anode and cathode on the primary side and between collector, emitter and base on the secondary side.
- (2) The isolation voltage tester with a zero-cross circuit shall be used.
- (3) The waveform of applied voltage shall be a sine wave.

• Inspection standard

Outgoing inspection standard for LITON products are shown below.

- (1) A single sampling plan, normal inspection level II based on MIL-STD-105D is applied. The AQL according to the inspection items are shown below.

Defect	Inspection item	AQL(%)	Judgement criterion
Major defect	<ul style="list-style-type: none">• Electrical characteristics• Unreadable marking• Open,short	0.25	Depend on the specification
Minor defect	<ul style="list-style-type: none">• Appearance• Dimension	0.4	

Fig. 1 Forward Current vs. Ambient Temperature

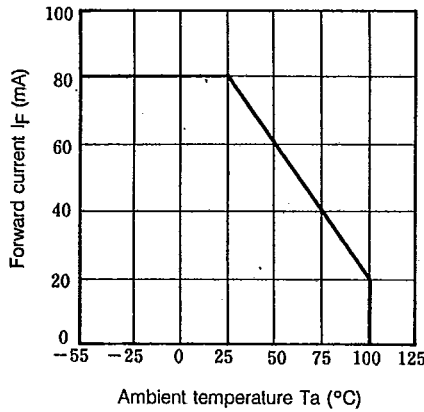

Fig. 2 Collector Power Dissipation vs. Ambient Temperature

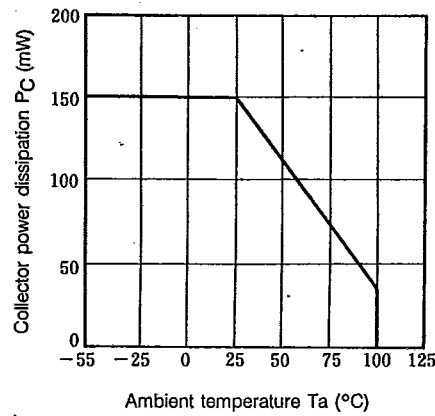

Fig. 3 Forward Current vs. Forward Voltage

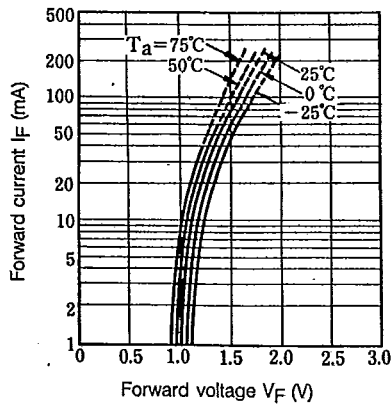

Fig. 4 Current Transfer Ratio vs. Forward Current

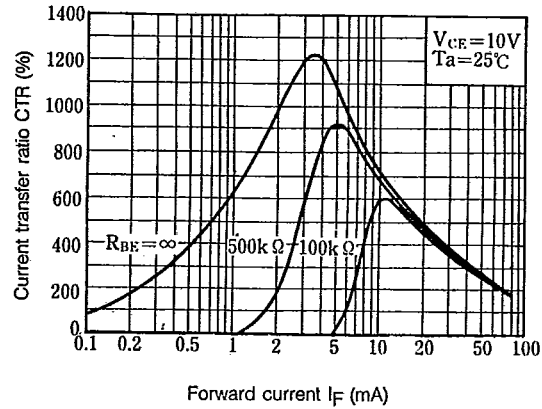

Fig. 5 Collector Current vs. Collector-emitter Voltage

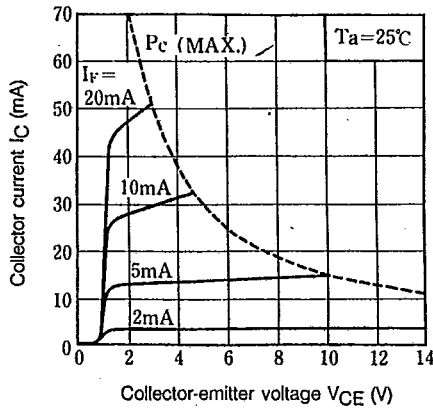
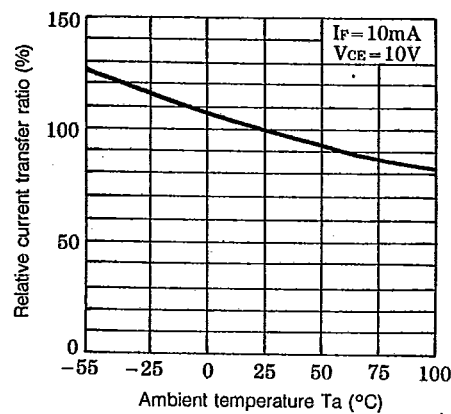

Fig. 6 Relative Current Transfer Ratio vs. Ambient Temperature



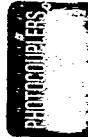

Fig. 7 Collector-emitter Saturation Voltage vs. Ambient Temperature

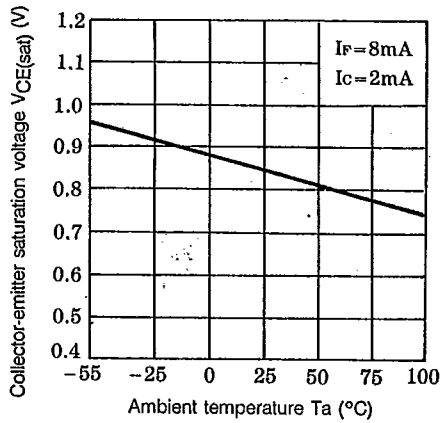

Fig. 8 Collector Dark Current vs. Ambient Temperature

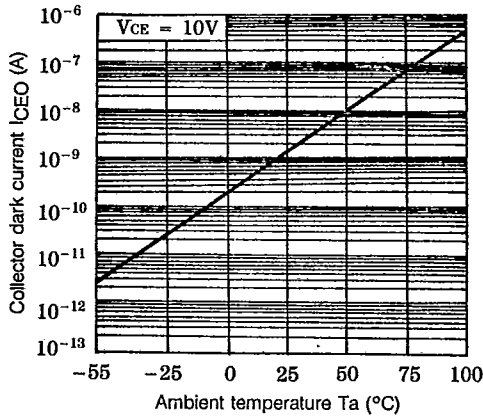

Fig. 9 Frequency Response

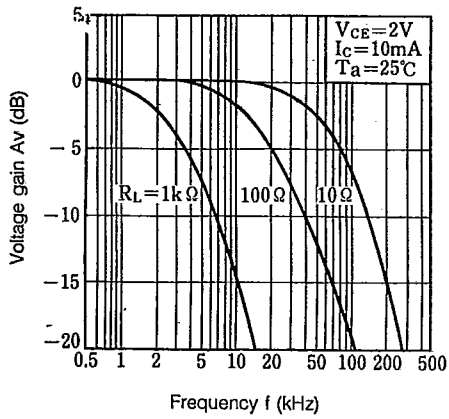

Fig. 10 Collector-emitter Saturation Voltage vs. Forward Current

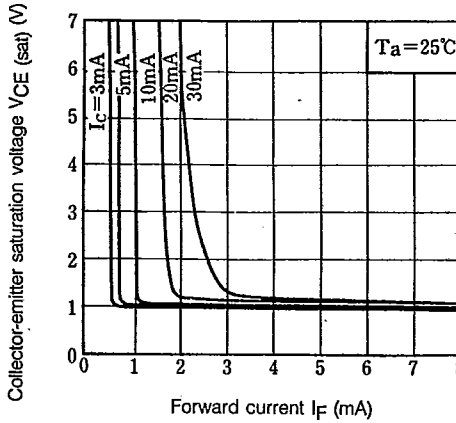

Fig. 11 Test Circuit for Response Time

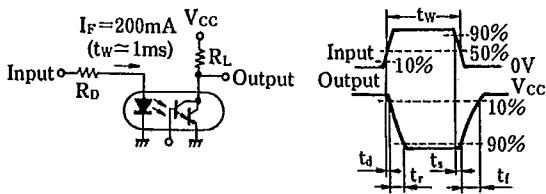
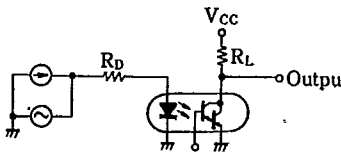

Fig. 12 Test Circuit for Frequency Response



PACKAGING

T-90-20

Reel Packaging (Axial Lead Units)

DEVICE TYPE	COMPONENT SPACE (MM) "A"	TAPE SPACE (MM) "B"	REEL DIA (MM) "D"	QUANTITY (EA)		CARTON	
				REEL	CARTON	SIZE (MM)	WEIGHT (KG)
DO-41 DO-41L	5±0.5	52.4±1.5	326~336	5000	20K	355 x 355 x 355	10.5
DO-201AD	10±0.5	52.4±1.5	326~336	1200	4.8K	355 x 355 x 355	9.0
P6(Aleg)	10±0.5	52.4±1.5	326~336	700	2.8K	355 x 355 x 355	8.8

The C dimension of Fig. 3 is between 3.17m.m. and 635mm greater than the length of the component involved.

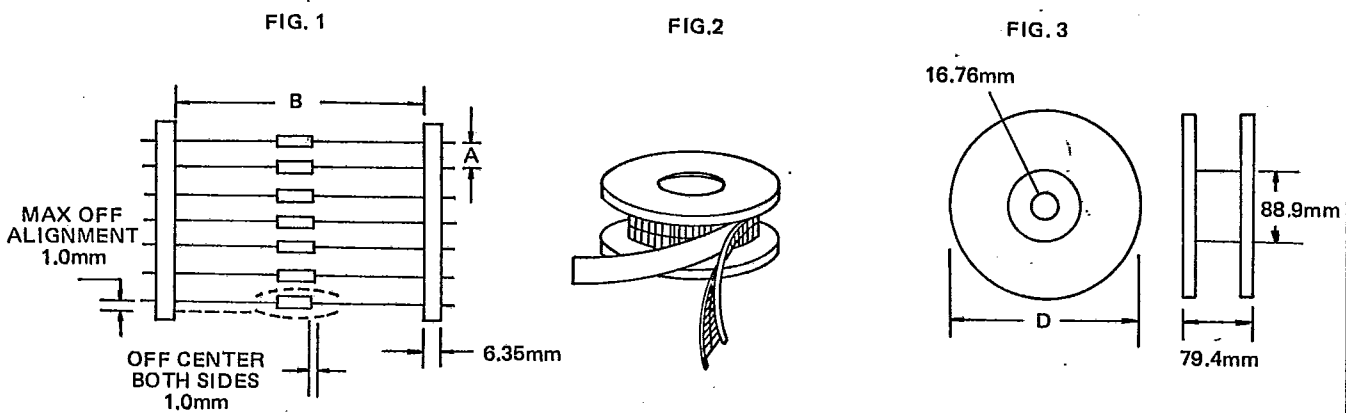

Bulk Packaging (Axial Lead Devices and Bridge Rectifiers)

DEVICE TYPE	PACKAGING SIZE (MM)		QUANTITY (EA)		APPROX GROSS WEIGHT (KG)	
	BOX	CARTON	BOX	CARTON	BOX	CARTON
DO-41 DO-41L	196 x 84 x 20	450 x 210 x 250	1000	50K	0.38	20
DO-201AD	305 x 93 x 59	355 x 355 x 355	1000	20K	1.35	28
P6(Aleg)	305 x 93 x 59	355 x 355 x 355	500	10K	1.2	24.5
PBM	357 x 125 x 60	530 x 360 x 340	1000	20K	1.5	32.3
PBDF	495 x 155 x 145	500 x 325 x 305	5000	20K	5.1	21.5
PBP	357 x 125 x 60	530 x 360 x 340	500	10K	1.5	31.5
PBL	375 x 220 x 155	470 x 385 x 455	1000	5K	5.7	30.5
PBPC-6	357 x 125 x 60	560 x 360 x 340	250	5K	1.1	22
PBPC-8	357 x 125 x 60	560 x 360 x 340	250	5K	1.7	35
KBPC	375 x 220 x 365	470 x 390 x 385	500	1K	15.1	31.5
KBPC-W	375 x 220 x 365	470 x 390 x 385	500	1K	14.5	30.0

AMMO BOX PACKAGING

BOX SIZE

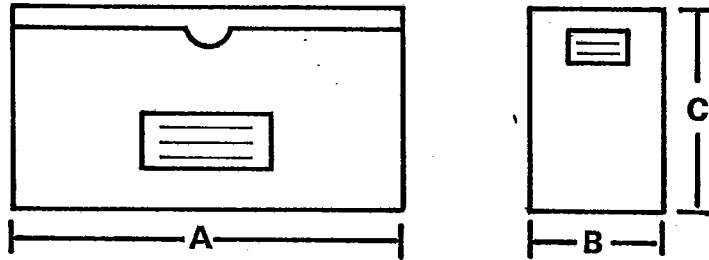

Unit:m. m.

Packaging	Products Outline	Dimension *A*	Dimension *B*	Dimension *C*	Q'ty per BOX
26MM Horizontal Ammo Pack	DO-41 DO-41L(0.6mm Lead)	255	50	95	3K
					3K
52MM Horizontal Ammo Pack	DO-41and DO-41L DO 201AD	250	75	92	3K
					0.8K

CARTON SIZE

Unit:m. m.

Packaging	Products Outline	length	Width	High	Q'ty Per Carton
26MM Horizontal Ammo Pack	DO-41 DO-41L(0.6mm Lead)	330	310	268	42K
					48K
52MM Horizontal Ammo Pack	DO-41and DO-41L DO 201AD	355	355	340	12K

PREFORMED LEAD DRAWING

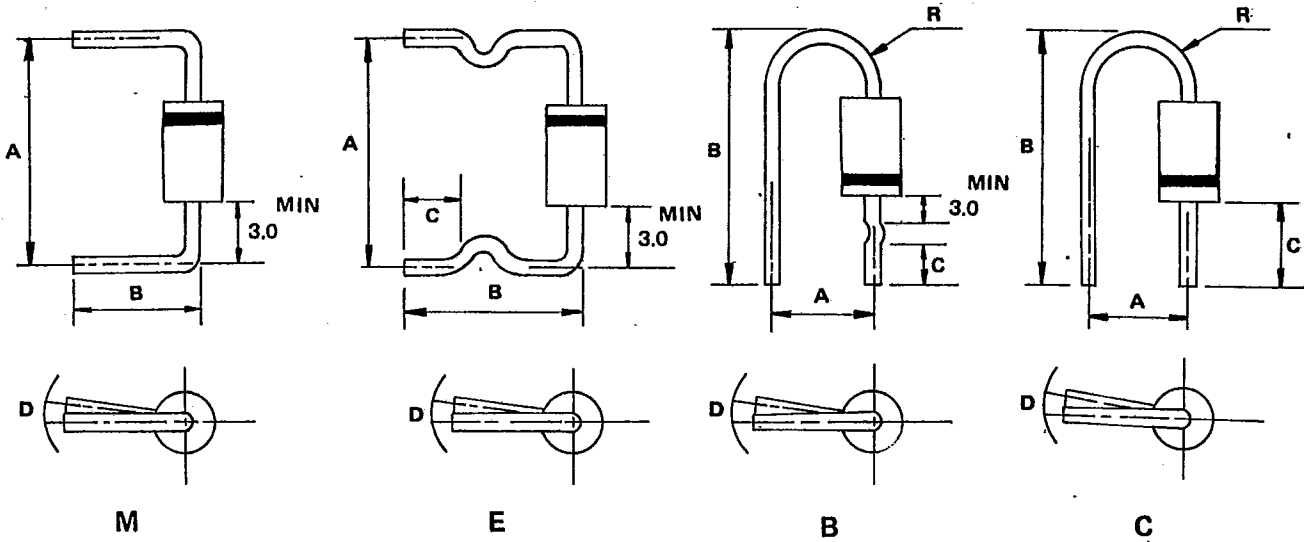

Case type	Preformed type	A (mm)		B (mm)		C (mm)		D (mm)		R (mm)	
		range	tolerance	range	tolerance	range	tolerance	range	tolerance	range	tolerance
D041	M	9.0-20.0	1.0	8.0-22.0	±0.5	-	-	1.5	max	-	-
	E	11.0-20.0	±1.0	11.0-16.0	±1.0	4.0-5.0	±0.5	1.5	max	-	-
	B	7.5	±0.5	19.0-22.0	±0.5	7.5	±0.5	1.5	max	2.5-4.0	Typ
	C	4.5	±0.8	18.0-19.0	±0.5	9.0	±0.5	1.5	max	2.5-4.0	Typ
D0201AD	M	15.0-20.0	±1.0	8.0-22.0	±1.0	-	-	2.0	max	-	-
	E	15.0-20.0	±1.0	10.0-22.0	±1.0	3.0-15.0	±0.5	2.0	max	-	-
P6(Aleg)	M	15.0-20.0	±1.0	8.0-22.0	±1.0	-	-	2.0	max	-	-